

DS201 PRO User's Manual

Contents

I Product Intro.....	2
II General Safety Rules	2
III Major Functions	2
IV Operation Precautions	3
V General Inspection.....	3
VI Functional Inspections.....	3
VII Battery Recharging Instruction.....	3
VIII Storage Instruction.....	3
IX Firmware Upgrades	3
X Product Familiarization.....	5
1. Interface and Buttons.....	5
2. Screen.....	5
XI Measurement Operation Instruction.....	6
1. Parameter Area Intro.....	6
2. Measurement Area Intro.....	6
3. Specific Parameters Intro.....	6
XII Application Examples.....	9
1. Example One: Measure Simple Signal.....	11
2. Example Two: Measure with Cursor.....	12
3. Example Three: Save Waveform Image.....	13
4. Example Four: Acquire Single Signal.....	14
5. Example Five: Compare Waveform Signals.....	15

I Product Intro

DS201 PRO pocket size oscilloscope is a compatible 32bit digital storage oscilloscope. Based on ARM Cortex™-M3, it's equipped with 320*240 color display, 8M Flash, USB port and recharging function. It's compact, simple to operate; meets the basic demands of school lab, electric furniture repairmen and electric engineering.

II General Safety Rules

To ensure your safety & avoid any damages to the product/connected devices, please read the following safety rules carefully. To avoid any possible dangers, please use this product according to the rules.

Use appropriate power cord. Please use dedicated power cord which is certified in the country/region.

Connect/disconnect properly. Do not plug/unplug when the probe(s)/test lead(s) is connected to the power source. Before you plug/unplug the current probes, please disconnect the power to the circuit-under-test.

Observe all terminal ratings. To avoid fire/electric shock, please don't measure signal with DC100V or above, or the device might be destroyed. Please read the manual carefully to know the detailed info of related ratings before connection.

Please do not operate in humid environment.

Please do not operate in inflammable/explosive environment.

Please keep the surface of the product clean and dry.

III Major Functions

Display	2.8" color TFT LCD
display resolution	320×240
Display Colors	65K
Virtual Broadband	0-200kHz
Max. Sampling Rate	1Msps 12 bit
Sampling Storage Depth	4096 points
Transverse Sensitivity	1uS/Div~2S/Div(1-2-5 stepping)
Vertical Sensitivity	10mv/Div~10V/Div(x1 probe)
	100mV/Div~10V/Div(x10 probe)
Input Resistance	>500K Ω
Max. Input Voltage	80Vpp (x1 probe)
Coupling Mode	DC
Triggering Mode	Auto, Normal, Single, None, Scan
Auto Measurement	frequency, cycle, duty, Vpp, Vram, Vavg, DC voltage
	Vertical Precise Measurement Cursor
	Horizontal Precise Measurement Cursor
	Rising/Falling Edge Trigger
	Triggering Cursor
	Triggering Sensitivity Cursor
	Hold/Run
Inbuilt Test Signal	10Hz~1MHz(1-2-5 stepping)
Waveform Storage	8M Flash
PC Connection Interface	Connection through USB

Recharging Method	Recharging through USB interface
Dimensions	88mm×59mm×11mm

IV Operation Precautions

■ Temperature:

Working condition: +0°C to +50°C

Non-working condition: -20°C to +60°C:

■ Humidity:

Working condition: High temperature: 40°C - 50°C, 0%-60%RH

Working condition: Low temperature: 0°C - 40°C, 10%-90%RH

Non-working condition: High temperature: 40°C- 60°C, 5%-60%RH

Non-working condition: Low temperature: 0°C - 40°C, 5%-90%RH

V General Inspection

When you get a new DS201 PRO, it's suggested to inspect the product by the following steps:

1. Inspect for damage caused by shipping.

If the carton/plastic protection pad is seriously damaged, please keep the package until the product and accessories pass the inspection electrically and mechanically.

2. Inspect the product

Please contact the company if the following problems occur: 1) product surface is damaged, 2) product doesn't work properly, 3) product does not pass performance test.

If the damage is resulted from shipping, please keep the package and contact the transportation department/RIGOL distributor who is in charge of this service, for repair or exchange.

VI Functional Inspection

Make a quick functional inspection to ensure the product is working soundly. Please perform following steps:

1. Turn on the power supply, access homepage of the oscilloscope.
2. Connect the oscilloscope with standard signals (e.g. square wave 20KHz, $V_{pp}=5V$), set the switch on probe tip as 1X, plug oscilloscope probe to the jack.

Check whether the measured signal value is the same as the standard value; it can be calibrated if the margin is small.

VII Battery Recharging Instruction

When the battery sign shows as “”, or when the display is dim, please recharge in time. The product can be power on or off while recharging.

VIII SD Card Storage Instruction

DS201 PRO built-in 8 m FLASH is used to store

IX Firmware Upgrade

To upgrade firmware, please perform following steps:

1. Open web to access www.minidso.com, download the latest applicable firmware to your PC.
2. Simultaneously press “” of DS201 PRO and turn on power supply, enter DFU firmware upgrade mode.
3. Use USB to connect DS201 PRO to your PC, a removable disk named DFU V3_28_D will appear on your PC. Copy the hex firmware to the root directory of your disk. After the extension of the firmware

changes from “hex” to “rdy”, restart DS201 PRO, thus firmware is upgraded.

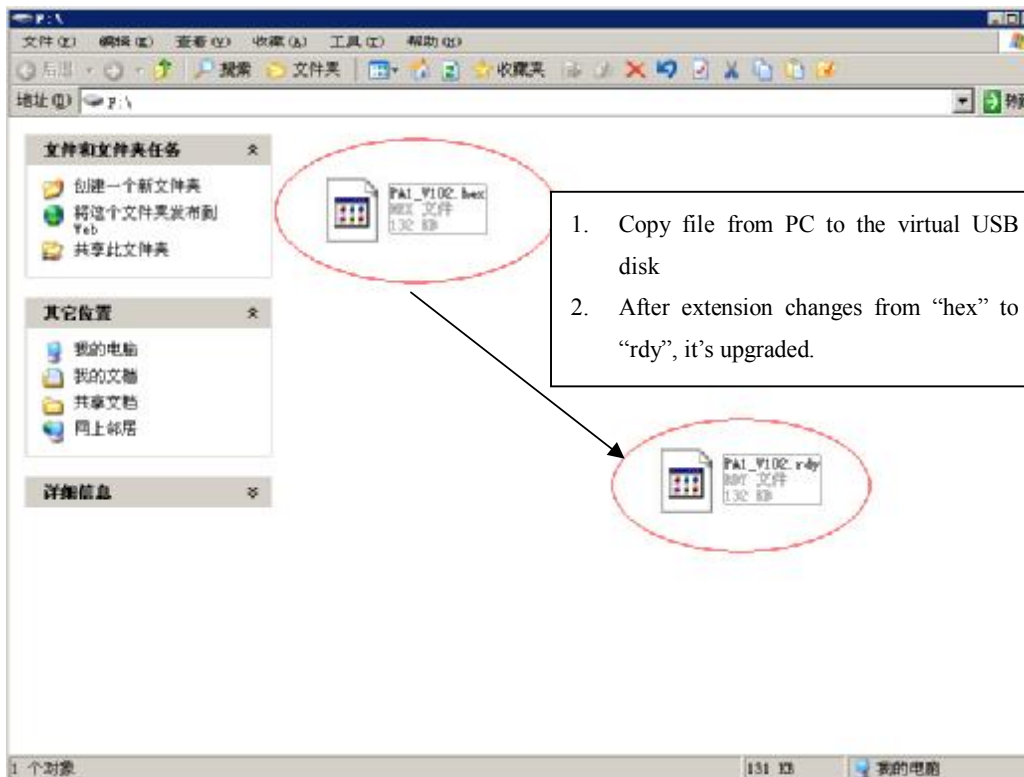

X Product Familiarization

1. Interface & Buttons

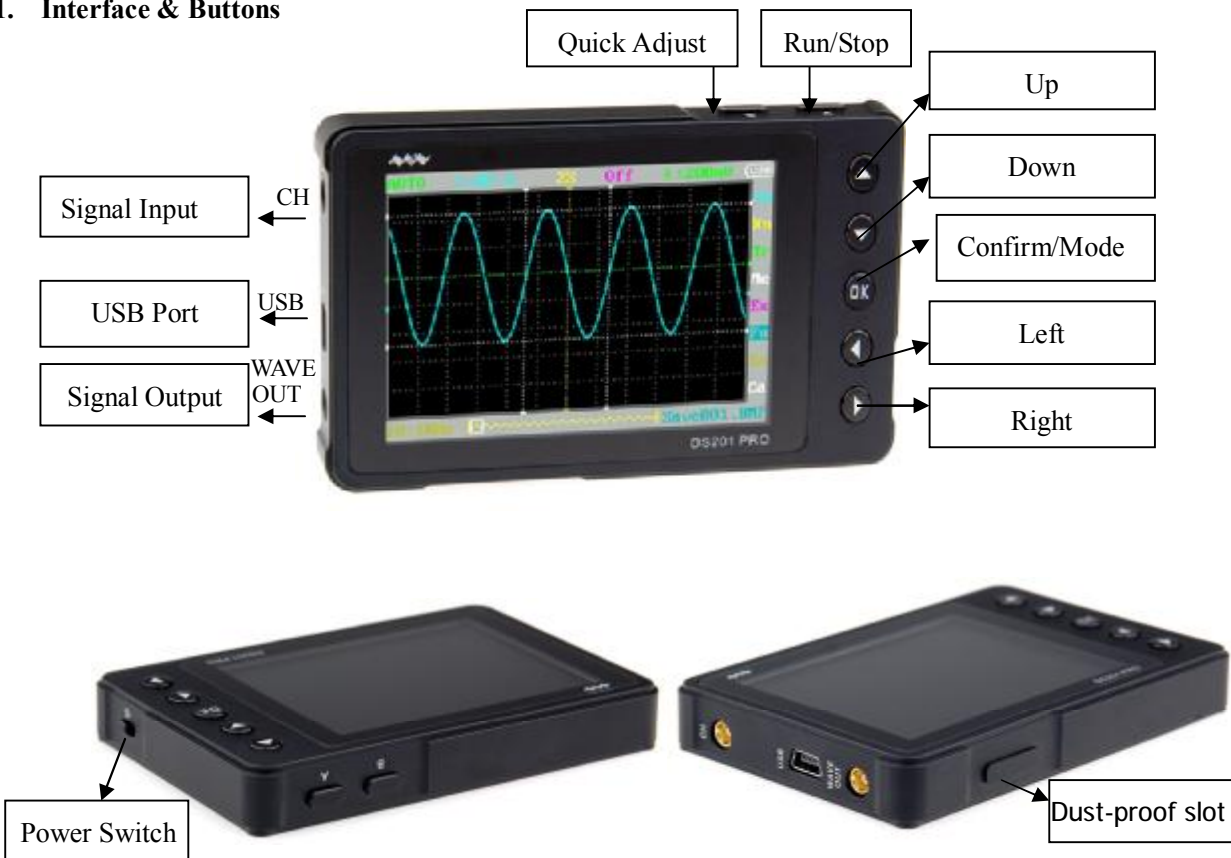





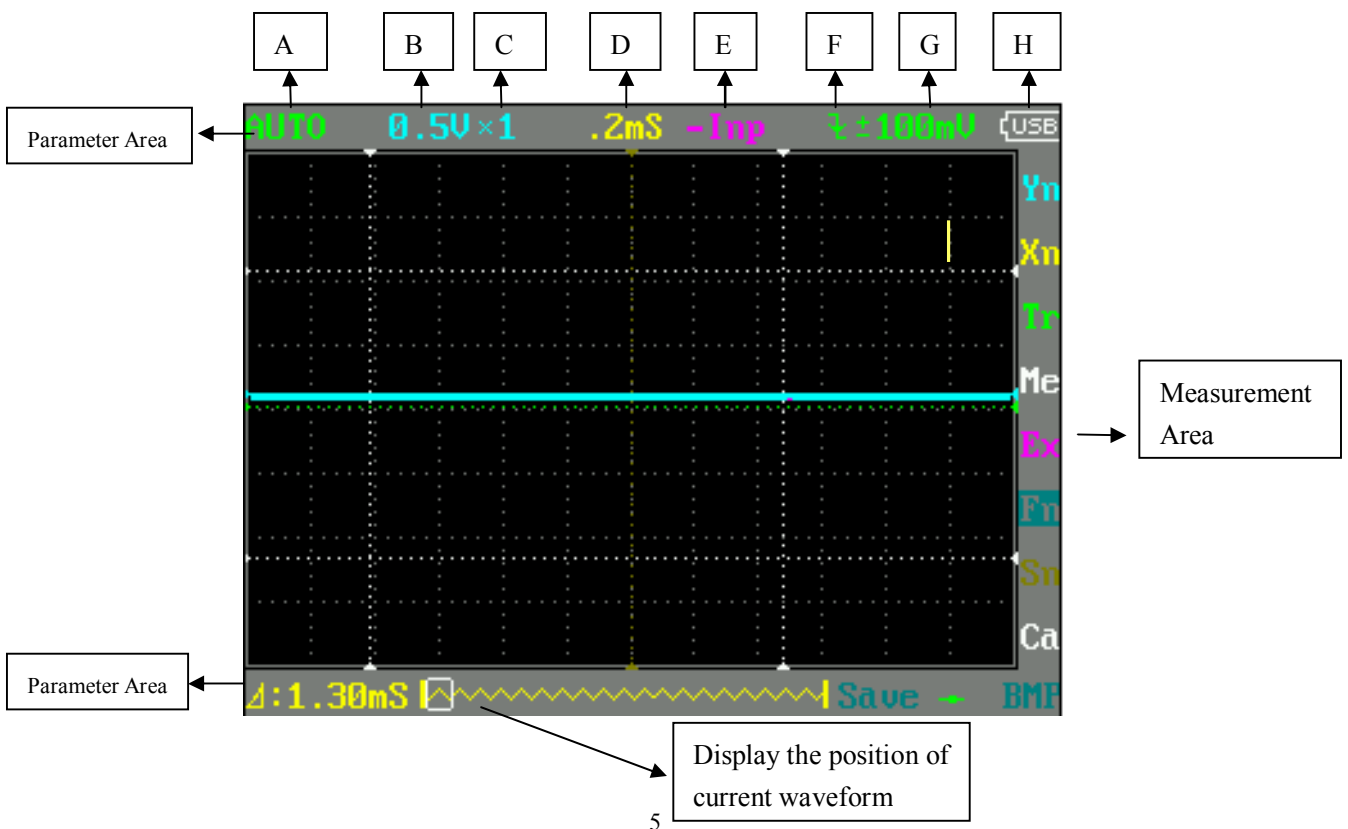

2. Screen

The screen display is depicted as below:



The table below shows the intro of button functions

	Function
	Run/Hold
	Choose to save current parameter setting(long press)
	Upward selection
	Downward selection
	(left/decrease) change setting parameters
	(right/increase) change setting parameters
	Menu
	Choose to save current file(long press)

NOTE: There are corresponding colors for items in Parameter Area and Measurement Area.

XI Measurement Operation Instruction



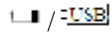



1. Parameter Area Intro

Menu	Item	Function(Operate: Press ×× or 00)
A	AUTO/NORM/SINGL/NONE/SCAN	Automation/Normal/Single/Slow Scan/Instant Scan
B	10mV-10V (1-2-5 stepping)	y-axis voltage per grid
C	×1/×10	multiple
D	1uS—2S (1-2-5 stepping)	x-axis voltage per grid
E	-Inp/Data/-Data/Inp+D/D-Inp/Inp-D	Operation of 2 waveforms (Inp is current waveform; D/Data is previously saved waveform)
F		Triggering Method: Falling edge trigger, Rising edge trigger.
G	±40mV—±3.9V	Horizontal triggering range
H		Power supply by battery/ by USB

2. Measurement Area Intro

Item	Function Intro
Yn	Y-axis Function Setting
Xn	X-axis Function Setting
Tr	Triggering Function Setting
Me	Measurement Function Setting
Ex	Waveform Operation Function Setting
Fn	Save and Load Function Setting
Sn	Output Waveform Parameters Setting
Ca	Calibration Setting

3. Specific Parameter Intro

Choose the items in parameter area through “” or “”. Press “” to access parameter setting menu, use “” and “” to choose the parameter item, and then use “” and “” to change the parameter value of the place where the cursor blinks.

(1) Annotation of Yn parameters

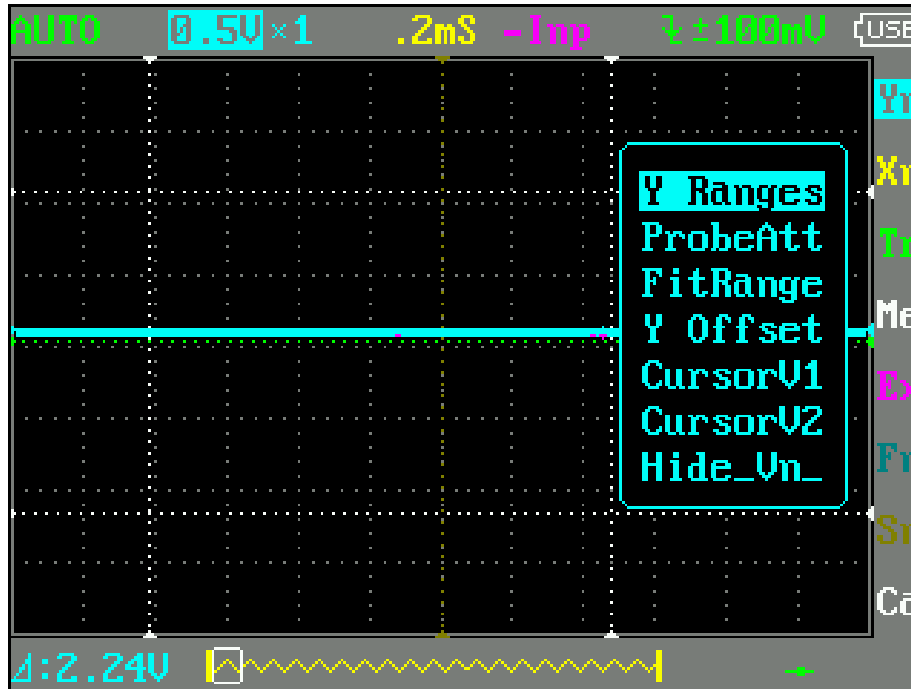

Y Ranges	Y-axis voltage per grid
ProbeAtt	Multiple
FitRange	Auto adjustment
Y Offset	Waveform adjusts up & down within the window
CursorV1	Cursor V1: top limit of visible trigger level
CursorV2	CursorV2: bottom limit of visible trigger level
Hide_Vn_	Hide/ Display Measurement Cursor

(2) Annotations of Xn Parameters

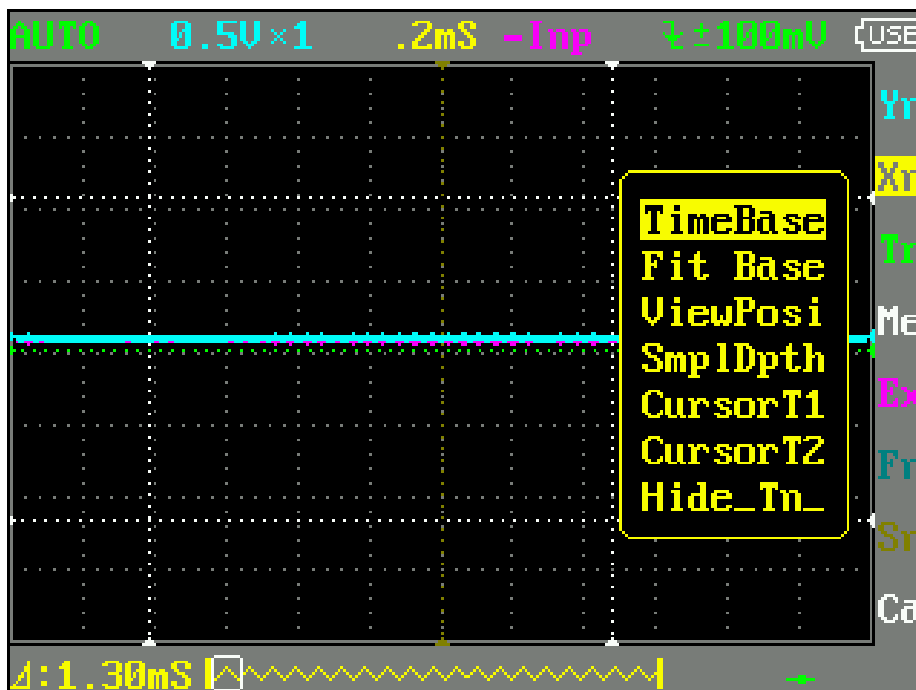

TimeBase	X-axis voltage per grid
Fit Base	Auto adjustment
ViewPosi	Horizontal movement to view waveform
SmplDpth	Internal storage depth (1k~6k)
CursorT1	Time measurement cursorT1
CursorT2	Time measurement cursorT2
Hide_Vn_	Hide/Display Measurement Cursor

(3) Annotations of Tr parameters

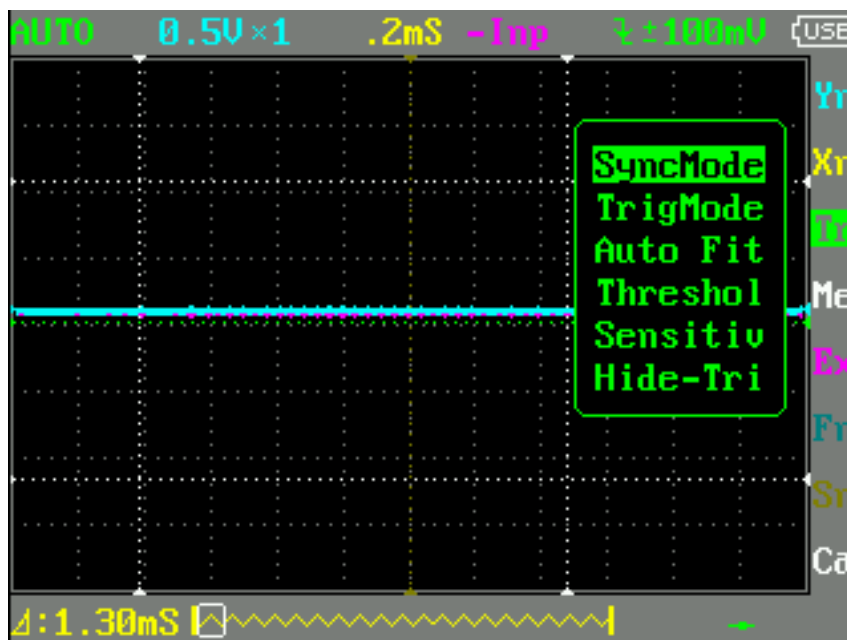

SyncMode	Choices of Triggering Mode
	AUTO/NORM/SINGL/NONE/SCAN Automation/Normal/Singular/Slow Scan/Instant Scan
TrigMode	Rising edge/falling edge triggering mode
Auto Fit	Auto adjustment
Threshold	Horizontal Triggering Position Level
Sensitiv	Horizontal Triggering Range
CursorTp	Hide/Display Horizontal Triggering Position Level

(4) Annotations of Me Parameters

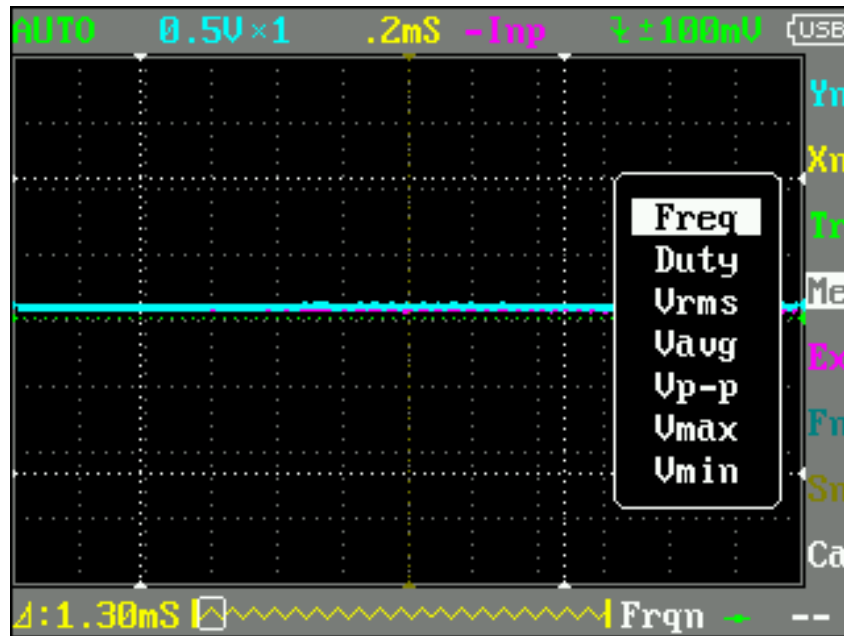

Freq	Signal Frequency
Duty	Dutyfactor
Vrms	Voltage Effective Value
Vavg	Average Value of Voltage
Vp-p	Peak-to-Peak Voltage
Vmax	Maximum Voltage
Vmin	Minimum Voltage

(5) Annotations of Ex Parameters



Ext Refn	2 waveforms operation (Inp is current waveform; D/Data is previously saved waveform)
	-Inp/Data/-Data/Inp+D/D-Inp/Inp-D/Off
Ext Posi	Display current waveform

(6) Annotations of Fn Parameters



Save Bmp	Save bmp file (waveform image) to the built-in U disk
Save Dat	Save dat file to the built-in U disk
Save Buf	Save buf file (sampling buffering data) to built-in U disk
Save Csv	Save csv file (export sampling buffering data)to built-in U disk
Load Dat	load Dat
Load Buf	load Buf

(7) Annotations of Sn Parameters

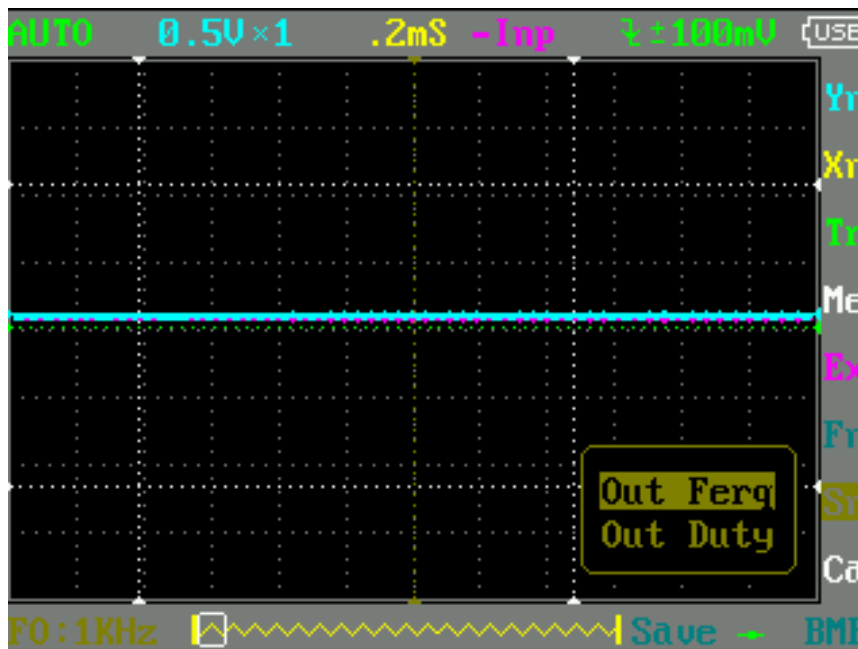

Out Freq	Signal output frequency
Out Duty	Signal output dutyfactor

(8) Annotations of Ca Parameters



Oscilloscope Calibration: Press 

Cal Zero	Calibration without voltage
CalRange	Calibration with voltage
Restore	Master Reset

XII Application Examples

1. Example One: Measure Simple Signal

Observe one unknown signal in a circuit, quickly measure & display the signal’s frequency & peak-to-peak value. Please operate according to following steps:

- Ø Connect the channel probe to the detection point of the circuit.
- Ø Set the Channel mode as AUTO, adjust the (Horizontal) time calibration and (Vertical) voltage calibration, make sure the signal displays clearly.
- Ø Adjust Threshold horizontal triggering position to make signal display stable.
- Ø Use “▲” or “▼” to choose Me items in Measurement Area, then press “OK”, use “▲” or “▼” to choose the

signal parameters that need analysis, e.g. Freq(frequency), Duty(dutyfactor), Vpp(peak-to-peak voltage)etc., the measured value will be displayed at the lower right corner of the screen, as shown in the image below:



Measured value

2. Example Two: Measure with Cursor

A cursor can be used to measure the time and voltage of the waveform very quickly.

(1) Measure the cycle of signal source

Please operate according to the following steps:

- Ø Use “▲” or “▼” to choose Yn items in Measurement Area.
- Ø Press “OK”
- Ø Use “▲” or “▼” to choose CursorV1
- Ø Use “▶” or “◀” to adjust the position of CursorV1 to the crest.
- Ø Use “▲” or “▼” to choose CursorV2
- Ø Use “▶” or “◀” to adjust the position of CursorV2 to the valley.

And get: $\Delta V = 1.00\text{mS}$ i.e. the cycle of signal source. As shown in the image below:

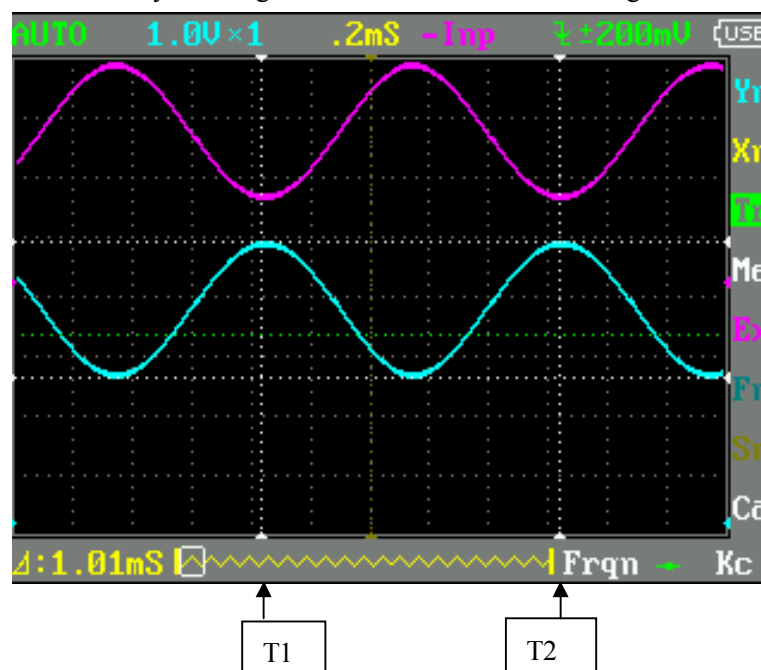

(2) Measure peak-to-peak value of the signal source.

Please operate according to following steps:

Ø Use “▲” or “▼” to choose Yn items in Measurement Area

Ø Press “OK”

Ø Use “▲” or “▼” to choose CursorV1

Ø Use “◀” or “▶” to adjust the position of CursorV1 to the crest

Ø Use “▲” or “▼” to choose CursorV2

Ø Use “◀” or “▶” to adjust the position of CursorV2 to the valley

And get: $\Delta V=2.08V$. i.e. the cycle of signal source, as shown in the image below:

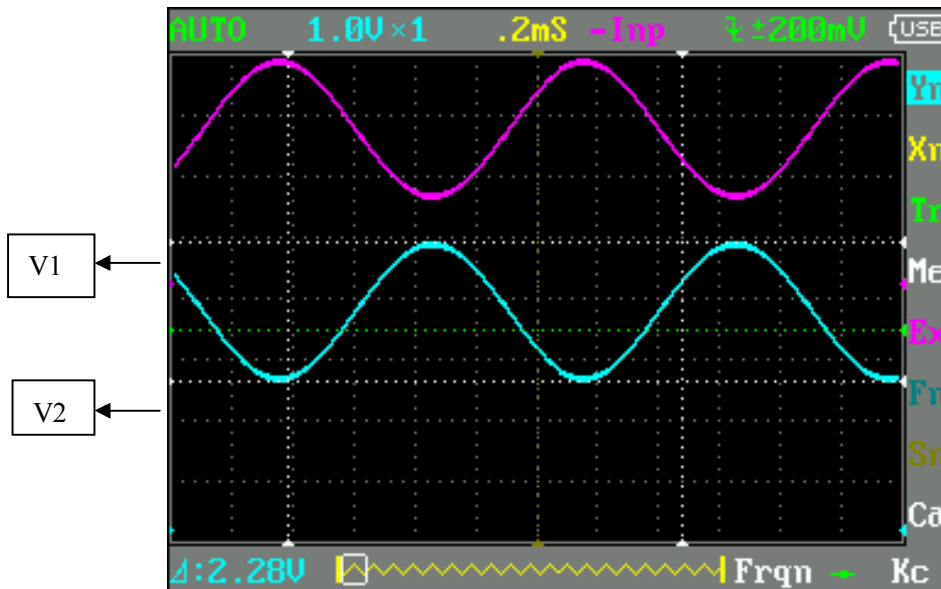

3. Example Three: Save waveform image

Sometimes waveform images need to be archived or analyzed on PC platform.

Please operate according to following steps:

Ø Use “▲” or “▼” to choose the Fn items in Measurement Area, press “OK”, use “▲” or “▼” to choose Save Bmp, and then use “◀” or “▶” to choose the file name on the lower right corner of the screen, e.g. Save000.BMP, as shown in the image; and then press “A” to save it to the built-in U disk.

Ø Just copy the image to your PC, and you can analyze the waveform image

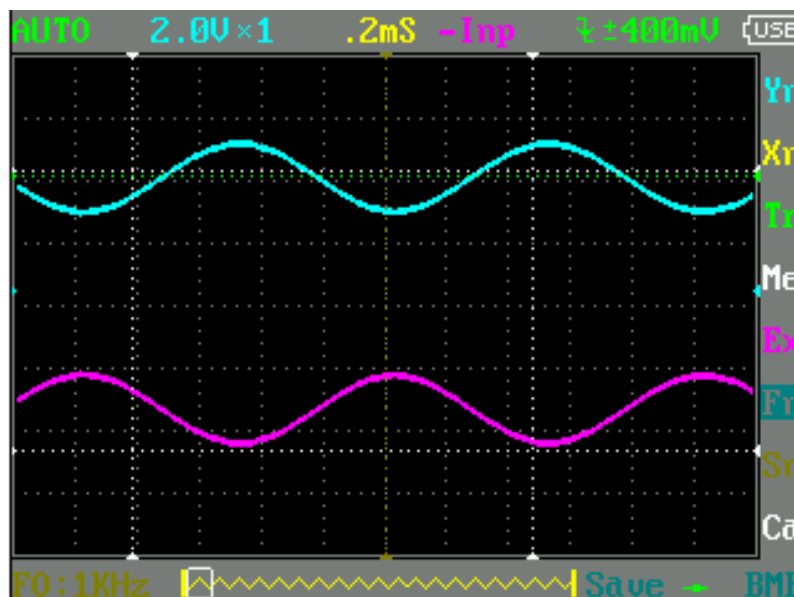

4. Example Four: Acquire Single Signal

It's the superiority and feature of digital oscilloscope to easily acquire non-periodic signals like impulsion and **sentus**. To acquire a single signal, you need a priori knowledge of it to set trigger level & trigger edge. E.g. if impulsion is a TTL PWL logic signal, **trig level** should be set as 2V, trig edge as rising edge trig. If the signal is not stable, it's suggested to observe in a normal triggering mode to define trig level & trig edge.

Operation steps are as follows:

- Ø Connect the channel probe to the detection point of the circuit.
- Ø Set the triggering: set F as  (rising edge trigger) Triggering setting: DC Coupling.
- Ø Adjust horizontal time level and vertical scale to proper range.
- Ø Adjust proper triggering PWL.
- Ø Use “▲” or “▼” to choose Tr items in Measurement Area, press “OK”; use “▲” or “▼” to choose Syncmode, and then use “◀” or “▶” to choose single touch mode, wait for the signal that match the triggering condition to show up. If there is one signal reaching the preset PWL, it will be sampled and displayed on the screen. As shown in the picture.

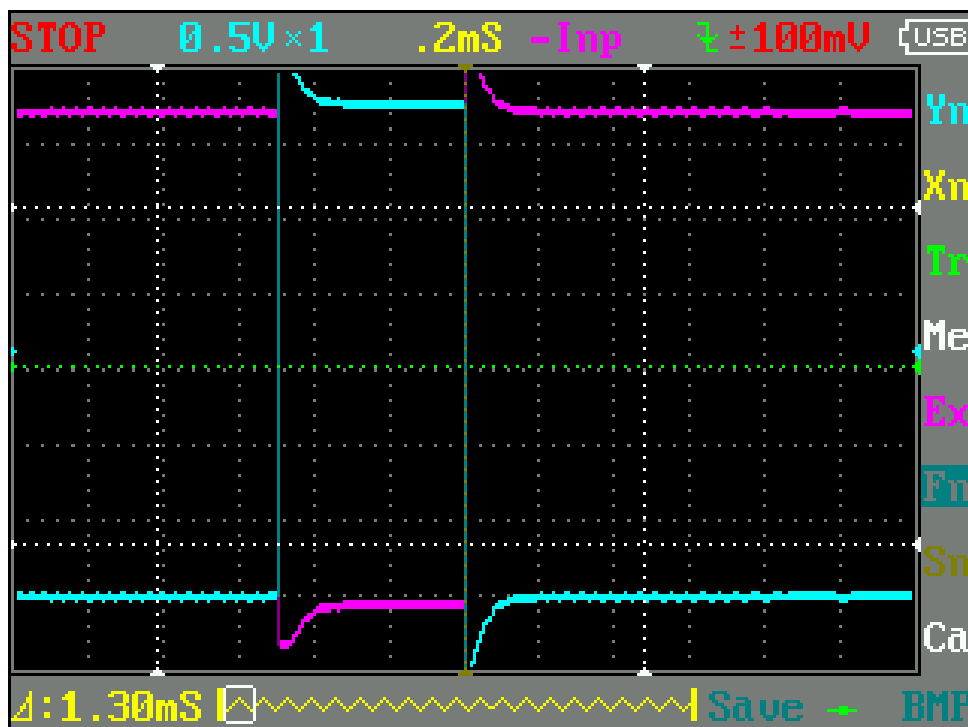

5. Example Five: Compare waveform signals

Please operate according to following steps:

Ø Input standard signal waveform to the channel, chose Data in EX, and then choose Save Dat 01 to save the waveform, as shown in the image below.

Ø Input unknown to-be-measured signal to the channel, choose Load Dat01→EX→Data, and then the to-be-compared waveforms are shown on the screen simultaneously, as shown in the image.

