

### USB type-c

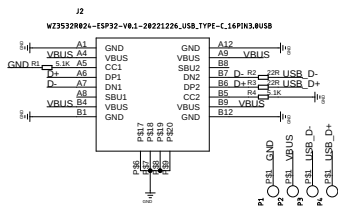

### USB to serial port

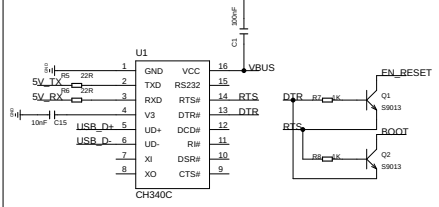

### POWER LED

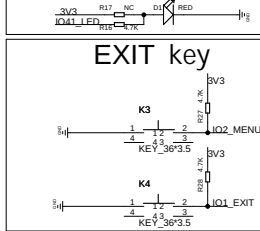

### ESP32-S3-WROOM-1-N8R8

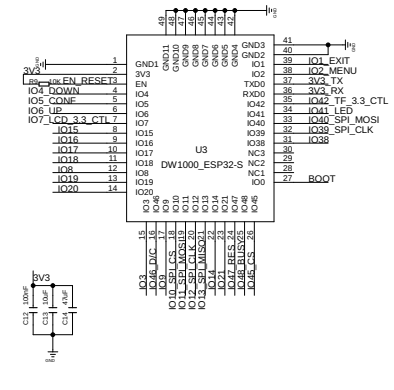
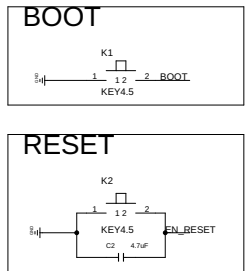

### GPIO

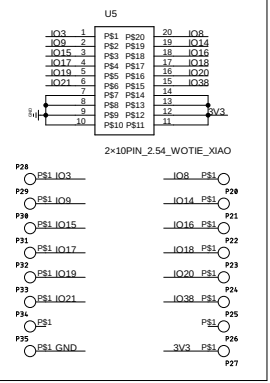

### BAT and control

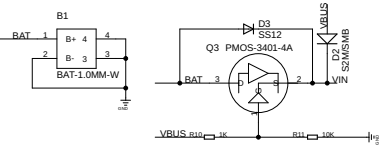

### swi tch

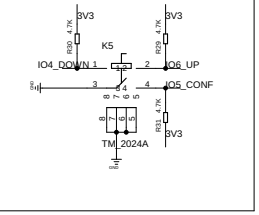

### TF Card

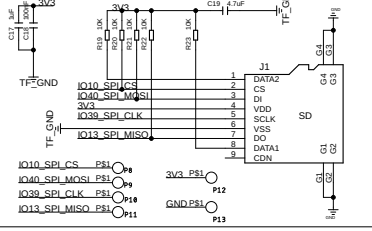

### 3.3V power

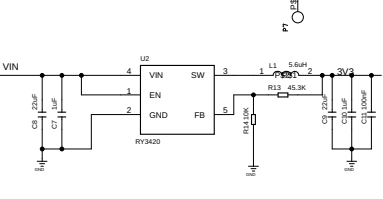

### Seri al level translation

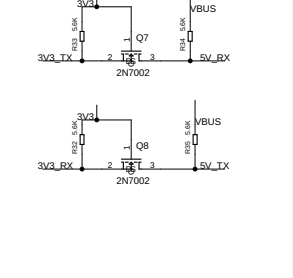

### TF LCD

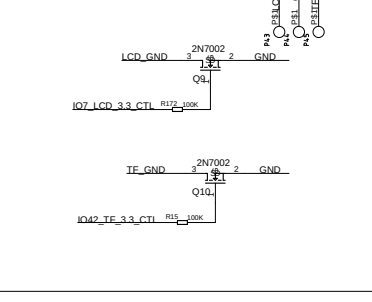

### EPD interface

