

ESP32S3

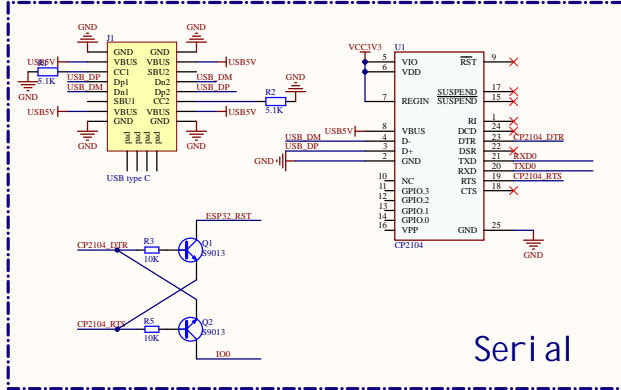

Serial

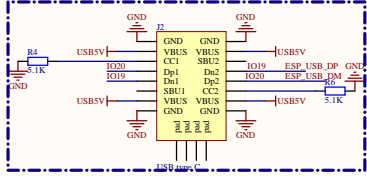

MIC0_WS 007
MIC0_DATA 015
MIC0_SCK 016

DC1_SDA 017
DC1_SCL 018
DCM1_CLK 048
DCM1_PCLK 048
DCM1_HSYNC 038
DCM1_VSYNC 021
DCM1_DP 045
DCM1_D1 047
DCM1_D2 044
DCM1_D3 040
DCM1_B4 045
DCM1_B5 042
DCM1_D6 041
DCM1_D7 039

WS2812_DAT 038
SD_CLK 003
SD_MOSI 004
SD_MISO 014
SD_CS 008
LCD_DC 009
LCD_SPI_CS 010
LCD_SPI_CLK 012
LCD_SPI_MOSI 011
LCD_SPI_RST ESP32_RST LCD_RST
LCD_SPI_BLK 046

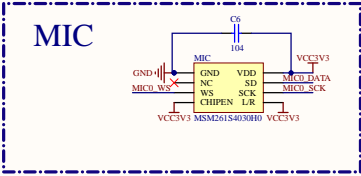
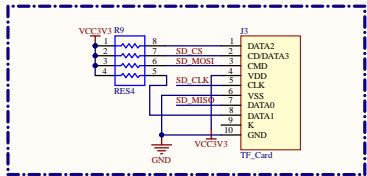
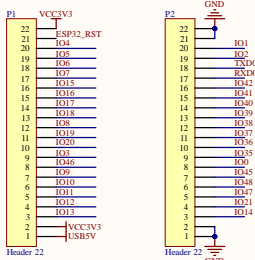
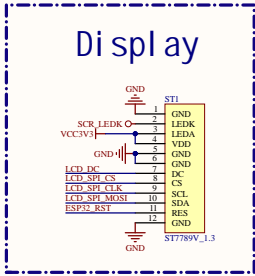
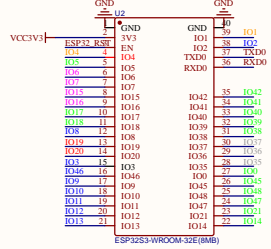
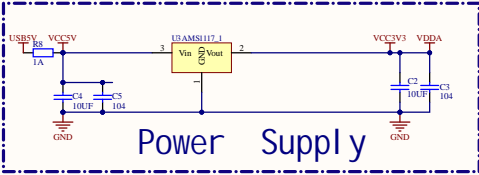

Title		
Size	Number	Revision
A2		
Date:	12/02/2022	Sheet of
File:	F:\Github\ESP32S3_SP_S4030H	Drawn By:

Comment	Description	Designator	Footprint	LibRef	Quantity
WS2812B		2812	LED_3528_RGB	WS2812B	1
BOOT	Switch	BOOT	KEY_1	SW-PB	1
105	Capacitor	C1	LC-0603_C	C	1
10UF		C2, C4	LC-0603_C	cap	2
104		C3, C5, C6	LC-0603_C	cap	3
USB type C		J1, J2	USB Type-C-16Pin_A	USB_C	2
TF_Card	TF卡座	J3	TF卡座	TF_Card	1
MSM261S4030H0		MIC	MSM261S4030H0	MSM261S4030H0	1
Header 22	Header, 22-Pin	P1, P2	HDR1X22	Header 22	2
S9013		Q1, Q2	SOT23-3N	Q S9013	2
SS8050	高频放大-NPN型	Q3	SOT23-3N	8050-SMD	1
5.1K	普通电阻	R1, R2, R4, R6	LC-0603_R	RES	4
10K	[NoValue], 普通电阻	R3, R5, R7, R12	LC-0603_R	R_0Ω_0603, RES	4
1A	普通电阻	R8	0805_R	RES	1
RES4		R9	RCA-8P4R-0603	RES4	1
10R	普通电阻	R10	LC-0603_R	RES	1
RST	Switch	RST	KEY_1	SW-PB	1
ST7789V_1.3		ST1	ST7789V_12Pin	ST7789V_1.3	1
CP2104		U1	QFN24 4x4_N	CP2104	1
ESP32S3-WROOM-32E(8MB)		U2	ESP32S3-WROOM-1	ESP32S3-WROOM-1	1
AMS1117_1		U3	SOT-89(SOT-89-3)	AMS1117_1	1